

Dynamic mechanical properties of photo resist thin films

Rwei-Ching Chang^{1,*}, Feng-Yuan Chen² and Pao-Hsiang Yang¹

¹*Department of Mechanical and Computer-Aided Engineering, St. John's University, Tamsui, Taipei 25135, Taiwan*

²*Department of Mechanical Engineering, Lee-Ming Institute of Technology, Taishan, Taipei 243, Taiwan*

(Manuscript Received May 31, 2007; Revised August 30, 2007; Accepted September 30, 2007)

Abstract

Photo resist thin films have mainly been used and investigated for versatile applications of micro electronic mechanical systems because of its outstanding aspect ratio and attainable film thickness. An accurate structure properties derived from validated material characterization is required in engineering applications. In this work, dynamic responses of photo resist thin films are tested by a nanoindentation in association with a dynamic mechanical analysis, where the thin film is coated on a silicon wafer by spin coating. The results show that the storage modulus of the photo resist thin film remains constant at the beginning and then increases as the indentation depth increases. Meanwhile, the loss modulus increases as the indentation depth increases. Varying the film thickness shows that the substrate effect plays an important role in determining the dynamic properties of thin films. However, the results agree well with the bulk material when the amplitude of nanoindentation is relatively small. It illustrates the dynamic mechanical analysis can be an efficient method to characterize the viscoelastic properties of thin films, but proper attention on the test parameters is needed.

Keywords: Thin films; Photo resist; Dynamic responses; Nanoindentation

1. Introduction

The usage of photo resist thin films for many micro electronic mechanical systems has been reported [1], pointing out the promising applicability of this material for mechanical and micro components. Characterizing the properties of the photo resist thin films is of importance for engineering applications. In the measurement of mechanical properties of micro-structures, the nanoindentation test becomes a popular technique because of its accuracy and simplicity. The nanoindentation test is frequently used to measure elastic modulus and hardness, even other properties, of small components such as nanometric thin films. However, although there are many publications in nanoindentation applications, much fewer studies deal

with the measurement of viscoelastic properties of polymer materials such as photo resist thin films.

For viscoelastic materials, it is very difficult to obtain meaningful and accurate data using quasi-static testing due to creep and strain rate effects [2]. Additionally, in the case of viscoelastic materials, it is desirable to have the capability of characterizing both components of the complex modulus, the storage and the loss modulus. It is very challenging and time consuming to accurately quantify the complex modulus of polymeric materials using quasi-static techniques, requiring numerous tests and copious amounts of analysis.

Standard analysis methods of quasi-static nanoindentation load/displacement data assume purely elastic/plastic material behaviour, particularly during the loading and unloading portions of the test [3]. This assumption ignores viscoelastic effects that exist

*Corresponding author. Tel.: +886 2280 13131, Fax.: +886 2280 13143
E-mail address: rcc@mail.sju.edu.tw

throughout the entirety of the indentation test. The most commonly accepted quasi-static analysis measures stiffness by calculating the slope of the initial portion of the unloading curve. This analysis assumes that all recovery observed during the unloading is elastic recovery, which is true for most ceramics and metals. However, most polymers show strongly viscoelastic behaviours, which imply a time-dependent recovery. Therefore, the unloading portion of the load/displacement data is a convolution of elastic and viscoelastic recovery, rendering it nearly impossible to calculate a true modulus.

In dynamic mechanical properties characterization, Yin et al. [4] used a shaker to exert dynamic indentation to the specimen. From the detected mechanical impedance, the complex modulus of the testing specimen was then deduced by using a viscoelastic model. For thin films, Gonda et al. [5] used nanoindentation experiments to determine the viscoelastic properties of a thin polymer film on a silicon substrate. They kept a constant indent load and measured the time-dependent displacement. Then the viscoelastic properties can be found from the mea-

sured indentation-creep curves. Odegard et al. [6] used a nanoindentation testing to measure the dynamic viscoelastic properties of polymer materials. They found the results measured from nanoindentation agreed with those from bulk dynamic mechanical testing. In addition, they also found that the harmonic frequency of nanoindentation does not have a significant effect on the measured storage and loss moduli of specimens.

In this work, a nanoindentation in association with a dynamic mechanical analysis is used to evaluate the dynamic viscoelastic properties of photo resist thin films coated on silicon substrates. The storage and loss modulus of the thin films are discussed for various film thicknesses.

2. Fabrication of photo resist thin films

The photo resist thin films are fabricated by spin coating as shown in Fig. 1. The spin coating uses centrifugal force to spread coating solution over the substrate surface. This technique is efficient and yields well-defined coating coverage. In this study, the coating material is SU8 negative photo resist (GM 1040) [7] and the substrate is silicon wafer with the (100) plane normal to the coating surface. The substrate surface is carefully cleaned by acetone and de-ionized water before coating. The photo resist solution is dropped at the center of the spinning substrate, then the centrifugal force spreads the solution across the substrate surface and all excess are spun off.

The spin coating process is shown in Fig. 2, which basically includes two stages. The first stage dispenses the coating solution to fully cover the substrate with 500 rpm and 30 sec. Immediately following the dispensing stage, the sample accelerates to a specified spin speed. The spin speed and spin time control the thickness of the coating layer. The spin time is 60 sec in the present work. After coating, the sample is heating at 55 °C and 3 min until completely wet out.

The film thickness fabricated by different spin speed is measured by an ellipsometer, as shown in Fig. 3. It illustrates the thickness exponentially decreases with the spin speed where the film thickness is about 8000 nm for 3000 rpm, and 1000 nm for 9000 rpm, or

$$T = 30848 e^{-0.000414R} \quad (1)$$

where T denotes the thickness (nm) and R is the spin speed (rpm).

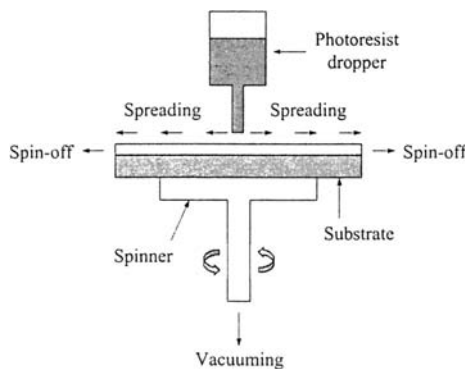

Fig. 1. Spin coating sketch.

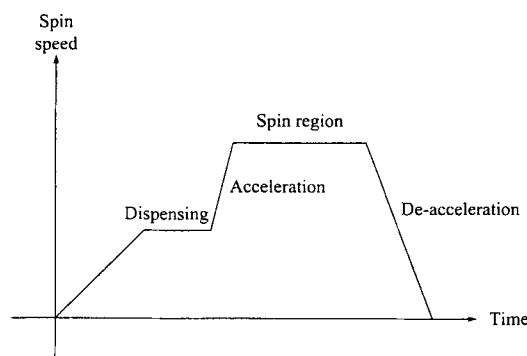

Fig. 2. Spin coating process.

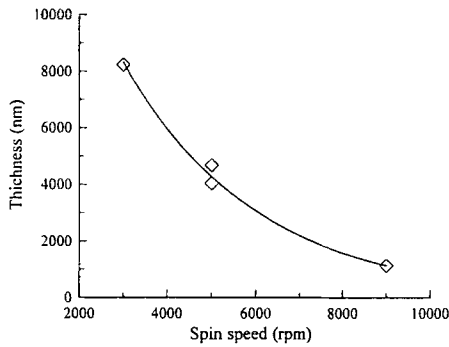

Fig. 3. Photo resist film thickness at various spin speed.

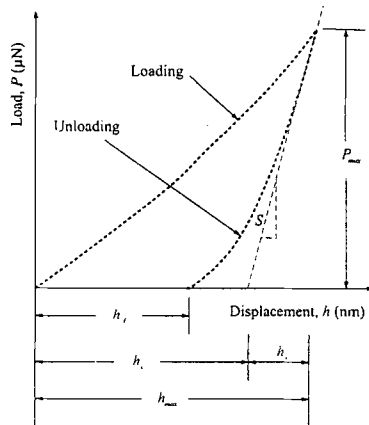

Fig. 4. Loading and unloading curve of nanoindentation.

3. Nanoindentation

Nanoindentation is one of the most efficient techniques to determine the mechanical properties of thin films. The hardness and elastic modulus are the two mechanical properties measured most frequently by using the nanoindentation technique. As the indenter presses into the specimen, both elastic and plastic deformations occur and result in a formation conforming to the shape of the indenter. During the indenter withdraw, it assumes that only the elastic portion of the displacement is recovered, which facilitates the use of an elastic solution in modelling the contact process. Therefore, nanoindentation hardness H can be defined as [8, 9]

$$H = \frac{P_{max}}{A_c} \tag{2}$$

where P_{max} denotes the peak load and A_c is the projected contact area. The hardness represents the mean pressure that a material can support under loading. The elastic modulus of the indented

specimen can be inferred from the initial unloading contact stiffness, $S = dp/dh$, i.e., the slope of the initial portion of the unloading curve as shown in Fig. 4 and Fig. 5. Based on the indentation analysis developed by Snedden [10], the relation between the contact stiffness, contact area, and elastic modulus can be derived as

$$S = 2\beta \sqrt{\frac{A_c}{\pi}} E_r \tag{3}$$

where β is a constant that depends on the geometry of the indenter, $\beta = 1.034$ for standard Berkovich indenter, and E_r is the reduced elastic modulus, which accounts for the elastic deformation occurs in both the specimen and the indenter. E_r is given by

$$\frac{1}{E_r} = \frac{1-\nu^2}{E} + \frac{1-\nu_i^2}{E_i} \tag{4}$$

where E and ν are the elastic modulus and Poisson's ratio for the specimen, respectively, and E_i , ν_i are the same quantities for the indenter.

For an indenter with a known geometry, the projected contact area is a function of the contact depth. Considering a perfect Berkovich indenter, the area function is

$$A_c = f(h_c) = 24.56h_c^2 \tag{5}$$

where h_c indicates the contact depth. However, the indenters used in practical nanoindentation testing are not ideally sharp. Therefore, tip geometry calibration or area function calibration is needed. A series of indentations is made on fused quartz at depths of interest. A plot of the contact area A versus the contact depth h_c can be fitted according to the following functional form

$$A_c = f(h_c) = 24.56h_c^2 + C_1h_c^1 + C_2h_c^{1/2} + C_3h_c^{1/4} + \dots + C_8h_c^{1/128} \tag{6}$$

where C_1 through C_8 are constants. The lead term describes a perfect Berkovich indenter, the others describe deviations from the Berkovich geometry due to the blunting of the tip [8].

However, the standard nanoindentation analysis ignores viscoelastic effects that exist throughout the indentation testing. For viscoelastic materials, the unloading portion of the load-displacement data is a convolution of elastic and viscoelastic recovery. Therefore, an improved method should be considered

in determining the properties of viscoelastic materials by using nanoindentation.

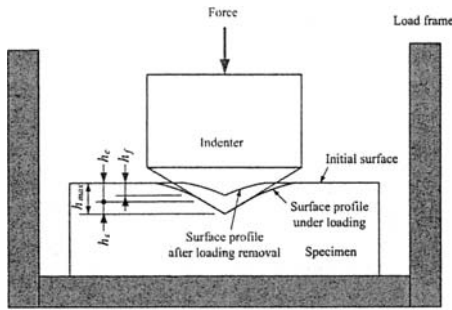

Fig. 5. Sketch of indentation testing.

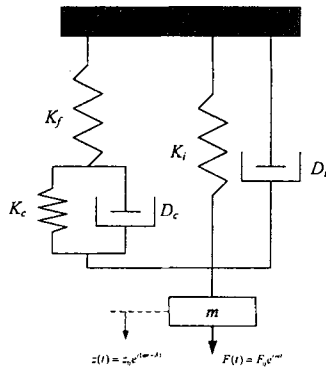

Fig. 6. Dynamic mechanical model of nanoindentation.

4. Dynamic mechanical analysis

Dynamic mechanical analysis is the most common used technique to characterize viscoelastic materials. The objective of this work is to investigate the ability of nanoindentation associated with dynamic mechanical analysis to determine the dynamic viscoelastic response of viscoelastic thin films. The model of dynamic mechanical analysis in nanoindentation testing [6, 11] is shown in Fig. 6, where m , K_i , D_i denote the mass, stiffness, damping of the indenter; K_c , D_c indicate the stiffness and damping of contact; and K_f is the load frame stiffness. The load frame stiffness (K_f), indenter mass (m), indenter stiffness (K_i), and indenter damping (D_i) are known constants, depending on the testing instrument. The contact stiffness (K_c), and contact damping (D_c), depending on the specimen material and contact conditions, will be determined in the dynamic testing. Referring to Fig. 6, the motion of equation can be written as

$$F(t) = m\ddot{z}(t) + (D_i + D_c)\dot{z}(t) + (K_i + K_c)z(t) \quad (7)$$

Assume that the load frame stiffness (K_f) provides the major contribution to the total stiffness such that it approaches infinite and can be neglected in Eq. (7). Suppose the driving force is

$$F(t) = F_0 e^{i\omega t} \quad (8)$$

where F_0 is the force amplitude and ω is the harmonic frequency. Therefore, the resulting displacement can be expressed as

$$z(t) = z_0 e^{i(\omega t - \delta)} \quad (9)$$

where z_0 is the displacement amplitude and δ is the phase angle. Substituting Eq. (8) and Eq. (9) into Eq. (7), we have

$$\frac{F_0}{z_0} e^{i\delta} = -m\omega^2 + i(D_i + D_c)\omega + (K_i + K_c) \quad (10)$$

or

$$\frac{F_0}{z_0} \cos \delta = -m\omega^2 + (K_i + K_c) \quad (11)$$

$$\frac{F_0}{z_0} \sin \delta = (D_i + D_c)\omega \quad (12)$$

From Eqs. (11) and (12), we have

$$K_c = \frac{F_0}{z_0} \cos \delta + m\omega^2 - K_i \quad (13)$$

and

$$\omega D_c = \frac{F_0}{z_0} \sin \delta - \omega D_i \quad (14)$$

In general, for linear viscoelastic materials, the constitutive behaviour can be expressed as the complex modulus

$$E = E' + iE'' \quad (15)$$

where the storage modulus (E') is the characteristic of elastic behaviour, and the loss modulus (E'') is of internal damping. Then, analogous to Eq. (3), the storage modulus through nanoindentation is given by

$$E' = \frac{K_c}{2\beta} \sqrt{\frac{\pi}{A_c}} \quad (16)$$

where the contact stiffness K_c is shown in Eq. (13). Similarly, the loss modulus is given by

$$E'' = \frac{\omega D_c}{2\beta} \sqrt{\frac{\pi}{A_c}} \quad (17)$$

where the contact damping ωD_c is defined in Eq. (14). Furthermore, the phase angle (δ) of the complex modulus can be written as

$$\tan \delta = \frac{E''}{E'} \quad (18)$$

which denotes the phase lag between the applied force and resultant displacement shown in Eq. (9). In this work, the testing frequency is 100 Hz and the testing load varies from 10 μN to 1000 μN while the amplitude is 10 μN . In this work, only one set of testing frequency and load amplitude is discussed, since they have no significant influence on the dynamic properties. This phenomenon agrees with other reports [4, 6].

5. Results and discussion

In dynamic mechanical analysis, the phase lag of the dynamic strain to stress provides information for calculating the storage modulus and loss modulus, or the complex modulus and phase angle as shown in previous discussion. The storage and loss moduli of the 1000 nm photoresist thin film are shown in Fig. 7. It shows the storage modulus increases from 4.5 GPa to 9.2 GPa as the indentation depth increases from 25 nm to 400 nm. Meanwhile, the loss modulus also increases from 0.1 GPa to 6.4 GPa as the indentation depth increases from 25 nm to 400 nm. Fig. 8 shows the storage and loss moduli of the 3000 nm photoresist thin film. It shows that the storage modulus remains at 4.5 GPa as the indentation depth increases from 25 nm to 100 nm, and then the storage modulus increases to 8.5 GPa as the indentation depth increases to 480 nm. Meanwhile, the loss modulus is 0.1 GPa as the indentation depth is 25 nm, and it increases to 4.8 GPa as the indentation depth increases to 480 nm. Fig. 9 shows the storage and loss moduli of the 9000 nm photoresist thin film. It shows the storage modulus remains at 4.5 GPa as the indentation depth increases from 25 nm to 200 nm, and increases to 6.5 GPa as the indentation depth increases to 500 nm. Moreover, the loss modulus increases from 0.1 GPa to 3.4 GPa as the indentation depth increases from 25 nm to 500 nm. Comparing Figs. 7–9, it shows both the storage modulus and loss modulus decrease as the film thickness increases. The results reveal the substrate effect has significant influence on the dynamic properties of thin films.

The amplitude of the complex moduli for 1000,

3000, and 9000 nm thicknesses of photoresist thin films are shown in Fig. 10. It shows the amplitude of the complex modulus increases from 4.5 GPa to 11.2 GPa as the indentation depth increases from 25 nm to 400 nm for 1000 nm thickness. For the 3000 nm film, the amplitude increases from 4.5 GPa to 8.8 GPa as the indentation depth increases from 25 nm to 480 nm. Similarly, the amplitude increases from 4.5 GPa to 7.3 GPa as the indentation depth increases from 25 nm to 500 nm for 9000 nm thickness. The results illustrate the amplitude of the complex moduli decreases as the film thickness increases. Moreover, the phase angles for 1000, 3000, and 9000 nm thicknesses of photoresist thin films are shown in Fig. 11. It shows the $\tan \delta$ increases from 0 to 0.7 as the indentation depth increases from 25 nm to 400 nm for the 10000 nm thickness film. The values of $\tan \delta$ also increase to 0.65 and 0.52 as the indentation depth increases to 480 nm and 500 nm for the 3000 nm and 9000 nm thickness films, respectively. It illustrates the phase angle slightly decreases as the film thickness increases.

The experimental results are summarized here and compared to the bulk material data [6, 7]. It indicates the storage modulus of various film thicknesses measured at 100 nm indent depth is equal to the bulk data. But the storage modulus increases as the indent depth increases. Furthermore, the loss modulus equals to the bulk data only at 9000 nm film thickness measured at 100 nm indent depth. The other loss moduli are larger than the value of the bulk material. The results clearly show that only small indent depth can measure the proper dynamic properties of thin films. Once the indent depth is large, the substrate effect should be carefully considered.

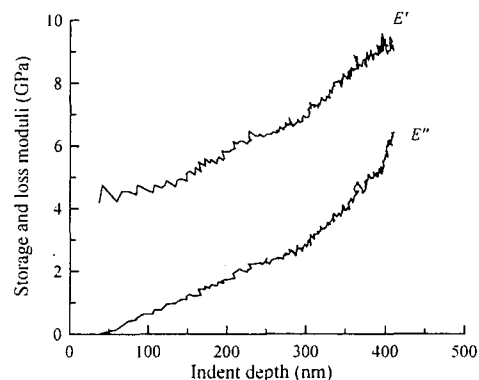

Fig. 7. Storage modulus and loss modulus of 1000 nm photoresist thin film.

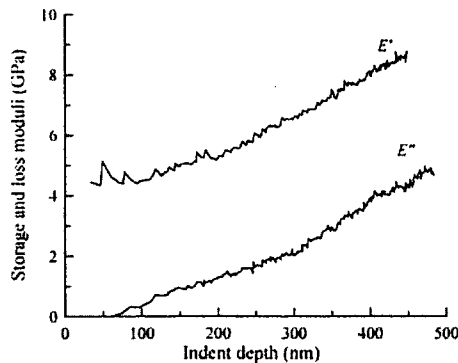

Fig. 8. Storage modulus and loss modulus of 3000 nm photo resist thin film.

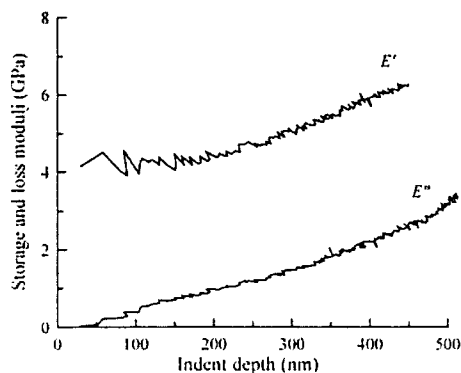

Fig. 9. Storage modulus and loss modulus of 9000 nm photo resist thin film.

6. Conclusions

In this study, nanoindentation in association with dynamic mechanical analysis is utilized to measure the dynamic viscoelastic properties of SU8 photo resist thin films coated on a silicon wafer substrate. The results show that the storage modulus of the photo resist thin film is consistent with the data of bulk material when the indent depth is small in comparison with the film thickness. And then the storage modulus increases as the indent depth increases. Furthermore, the indent depth is much crucial to the loss modulus which represents the internal damping of the specimen. These results reveal that the dynamic mechanical analysis of photo resist thin films is sensitive to the material difference between the thin film and the substrate.

7. Acknowledgements

The financial support of the National Science Council through Grant NSC 94-2212-E-129-002 is gratefully acknowledged.

References

- [1] V. Seidemann, S. Butefisch, S. Buttegenbach, Fabrication and investigation of in-plane compliant SU8 structures for MEMS and their application to micro valves and micro grippers, *Sensors and Actuators A*. 97 (2002) 457-461.
- [2] L. Klinger, E. Rabkin, Theory of nanoindentation creep controlled by interfacial diffusion, *Scripta Materialia*. 48 (2003) 1475-1481.
- [3] B.D. Beake and G.J. Leggett, Nanoindentation and nanoscratch testing of uniaxially and biaxially drawn poly(ethylene terephthalate) film, *Polymer*. 43 (2002) 319-327.
- [4] Y. Yin, S.F. Ling, Y. Liu, A dynamic indentation method for characterizing soft incompressible viscoelastic materials, *Materials Science and Engineering A*. 379 (2004) 334-340.
- [5] V. Gonda, K.M.B. Jansen, L.J. Ernst, J. den Toonder, G.Q. Zhang, Micro-mechanical testing of SiLK by nanoindentation and substrate curvature techniques, *Microelectronics Reliability*. 47 (2007) 248-251.
- [6] G.M. Odegard, T.S. Gates, H.M. Herring, Characterization of viscoelastic properties of polymeric materials through nanoindentation, *Experimental Mechanics*. 45 (2005) 130-136.
- [7] [Http://www.gersteltec.ch/](http://www.gersteltec.ch/)
- [8] W.C. Oliver, and G.M. Pharr, An improved technique for determining hardness and elastic-modulus using load and displacement sensing indentation experiments, *J. Mater. Res.* 7 (1992) 1564-83.
- [9] B. Bhushan, Handbook of micro/nanotribology, 2nd ed., CRC Press, Boca Raton, (1999).
- [10] I.N. Sneddon, The relation between load and penetration in the axisymmetric Boussinesq problem for a punch of arbitrary profile, *Int. J. Eng. Sci.* 3 (1965) 47-56.
- [11] W.N. Findley, Creep and Relaxation of Nonlinear Viscoelastic Materials, Dover Publications, (1989).